

5V, 2.5A, 550KHz High Efficiency Low Ripple Synchronous Step-Up Converter

Description

The FP6716 is a high efficiency, fixed frequency 550KHz, current mode PWM boost DC/DC converter which could operate battery such as input voltage down to 2.5V. The converter output voltage can be adjusted to a maximum of 5.25V by an external resistor divider. Besides the converter includes a 0.05Ω N-channel MOSFET switch and 0.08Ω P-channel synchronous rectifier. So no external Schottky diode is required and could get better efficiency near 90%.

The converter is based on a fixed frequency, current mode, pulse-width-modulation PWM controller that goes automatically into PSM mode at light load.

When converter operation into discontinuous mode, the internal anti-ringing switch will reduce interference and radiated electromagnetic energy.

The FP6716 is available in a space-saving SOP-8 (Exposed Pad) package for portable application.

Features

- High Efficiency up to 90%
- Low $R_{DS(ON)}$ Integrated Power MOSFET
- NMOS 50mΩ/PMOS 80mΩ
- Wide Input Voltage Range: 2.5V to 5.25V
- Fixed 550KHz Switching Frequency
- Low-Power Mode for Light Load Conditions
- ±2.0% Voltage Reference Accuracy
- ~~Adjustable Current Limit~~
- PMOS Current Limit for Short Circuit Protection
- Low Quiescent Current
- Input Under Voltage Lockout
- Internal Compensation Function
- Built-In Soft Start Function
- Over-Temperature Protection with Auto Recovery
- Output Overvoltage Protection
- SOP-8 (Exposed Pad) Pb-Free Package

Applications

- Portable Power Bank
- Wireless Equipment
- Handheld Instrument
- GPS Receiver

Pin Assignments

SP Package (SOP-8 Exposed Pad)

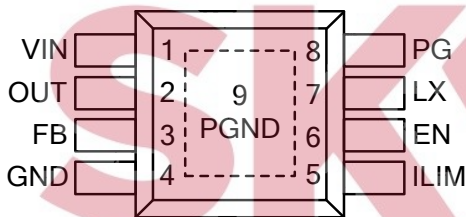
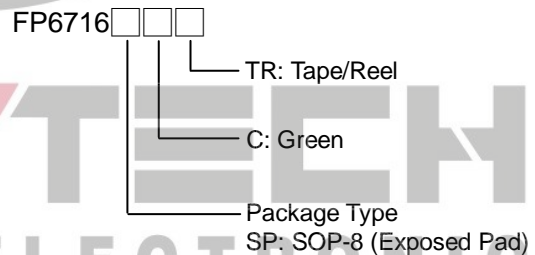
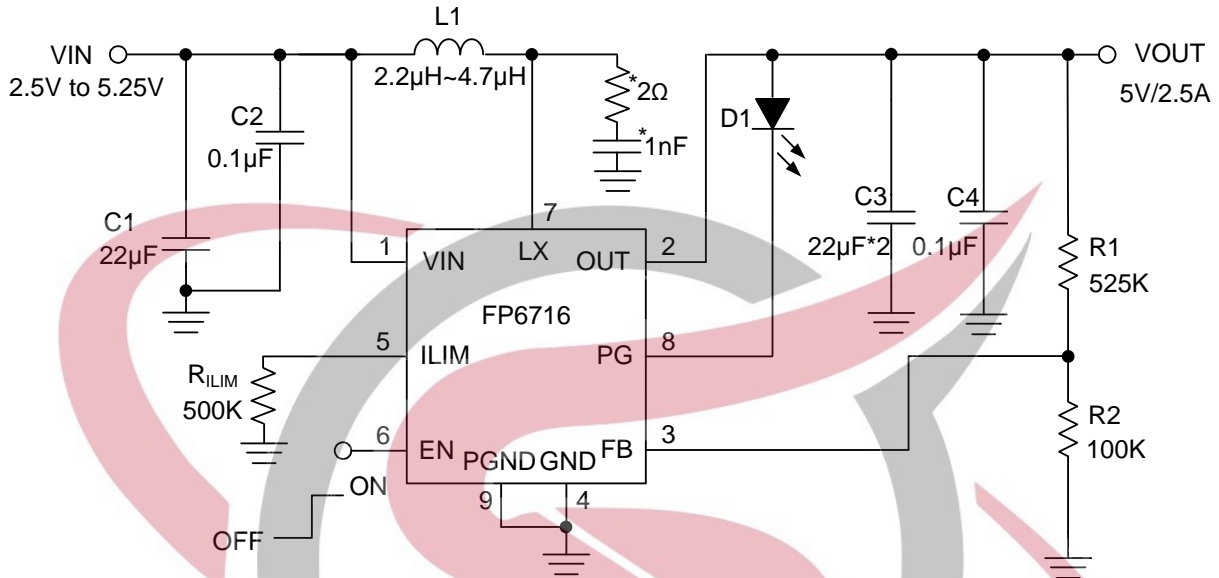

Figure 1. Pin Assignment of FP6716

Ordering Information



Typical Application Circuit



*R=2ohm and C=1nF are the recommend values in the reference circuit. In the real deign, different PCB layout might be cause different level of voltage spike. For reducing voltage spike, these two RC values could be optimized under different PCB layout conditions.

*R_{ILIM} 500Kohm is for fixed 3A current limit

Figure 2. Typical Application Circuit

Functional Pin Description

Pin Name	Pin No.	Pin Function
VIN	1	Power Supply Input Pin.
OUT	2	Output of the Synchronous Rectifier.
FB	3	Voltage Feedback Input Pin.
GND	4	Ground Pin. Connect GND to exposed pad.
ILIM	5	Programming Input for Average Input Current. Connect 500Kohm resistor to GND for 3A current limit
EN	6	Logic Controlled Shutdown Input.
LX	7	Power Switching Connection. Connect LX to the inductor and output rectifier.
PG	8	Power Good Indication Open Drain Pin.
PGND	9	Power Ground Pin.

Block Diagram

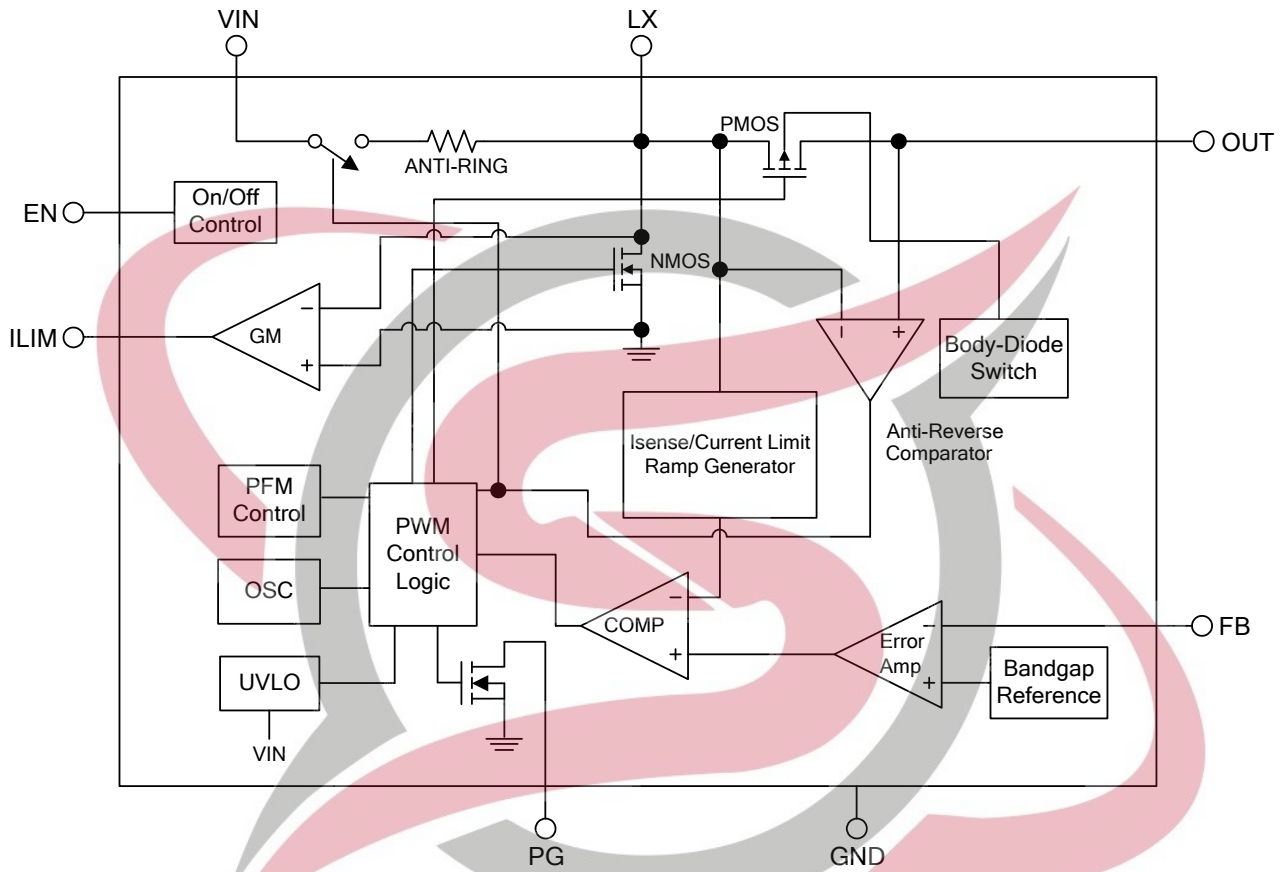
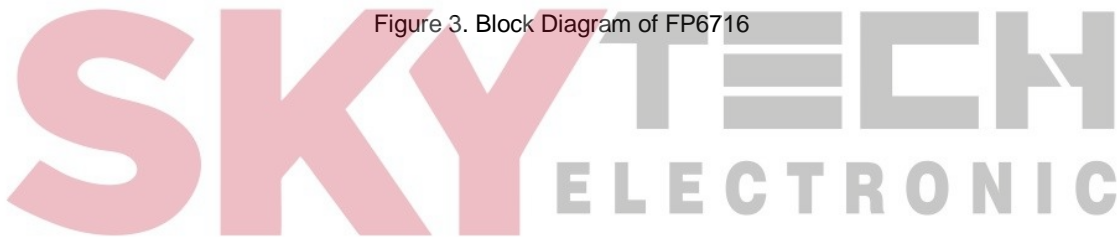

Figure 3. Block Diagram of FP6716



Absolute Maximum Ratings (Note 1)

- Supply Voltage V_{IN} ----- -0.3V to +6V
- LX Voltage V_{LX} ----- -0.3V to +6V
- All Other Pins Voltage ----- -0.3V to +6V
- Maximum Junction Temperature (T_J) ----- +150°C
- Storage Temperature (T_S) ----- -65°C to +150°C
- Lead Temperature (Soldering, 10sec.) ----- +260°C
- Package Thermal Resistance, (θ_{JA})
 SOP-8 (Exposed Pad) ----- 60°C/W
- Package Thermal Resistance, (θ_{JC})
 SOP-8 (Exposed Pad) ----- 15°C/W

Note 1 : Stresses beyond this listed under "Absolute Maximum Ratings" may cause permanent damage to the device.

Recommended Operating Conditions

- Supply Voltage V_{IN} ----- +2.5V to +5.25V
- Output Voltage Range ----- up to +5.25V
- Operation Temperature Range ----- -40°C to +85°C



Electrical Characteristics

($V_{IN}=3.3V$, $T_A=25^{\circ}C$, unless otherwise specified.)

Parameter	Symbol	Conditions	Min	Typ	Max	Unit
VIN Input Supply Voltage	V_{IN}		2.5		5.25	V
VIN Supply Current (Switching)		$V_{IN}=3.3V$, $V_{FB}=0.7V$ Measure V_{IN}		300	500	μA
VIN Supply Current (No witching)		$V_{FB}=1V$		45		μA
Feedback Voltage	V_{FB}	$2.5V \leq V_{IN} \leq 5.5V$	0.784	0.8	0.816	V
High-Side PMOSFET $R_{DS(ON)}$				80		m Ω
Low-Side NMOSFET $R_{DS(ON)}$				50		m Ω
High-Side MOSFET Leakage Current	$I_{LX(leak)}$	$V_{LX}=5.5V$, $V_{OUT}=0V$			10	μA
Low-Side MOSFET Leakage Current		$V_{LX}=5.5V$			10	μA
Oscillation Frequency	F_{OSC}		450	550	650	KHz
Short Circuit Trip Point		Monitored FB voltage		0.3		V
Short Circuit Current Limit		$V_{IN}=3.3V$		50		mA
Maximum Duty Cycle	D_{MAX}	$V_{IN}=3.3V$		90		%
Line Regulation		$V_{IN}=2.5V$ to $5.5V$, $I_{OUT}=100mA$			1	%
Load Regulation		$I_{OUT}=0.5A$ to $1.5A$		0.5		%
Input UVLO Threshold	$V_{UVLO(VTH)}$	V_{IN} Rising		2.3		V
Under Voltage Lockout Threshold Hysteresis	$V_{UVLO(HYS)}$	V_{IN} Falling		250		mV
OVP Threshold Voltage on OUT Pin				5.7		V
OVP Threshold Hysteresis				350		mV
Internal Soft-Start Time				1	3	ms
Power Good Active		Monitored FB, with respect to V_{FB}		90		%
Power Good Hysteresis				5		%
PG Low Output		Sink 20mA			0.4	V
PG Leakage Current		$PG=6.0V$			1	μA
EN Input Low Voltage	$V_{EN(L)}$				0.4	V
EN Input High Voltage	$V_{EN(H)}$		1.4			V
EN Input Current	I_{EN}	$V_{IN}=3.3V$		2		μA
Thermal Shutdown Threshold (Note 2)	T_{SD}			150		$^{\circ}C$
Thermal Shutdown Hysteresis				30		$^{\circ}C$

Note 2 : Not production tested.

Typical Performance Curves

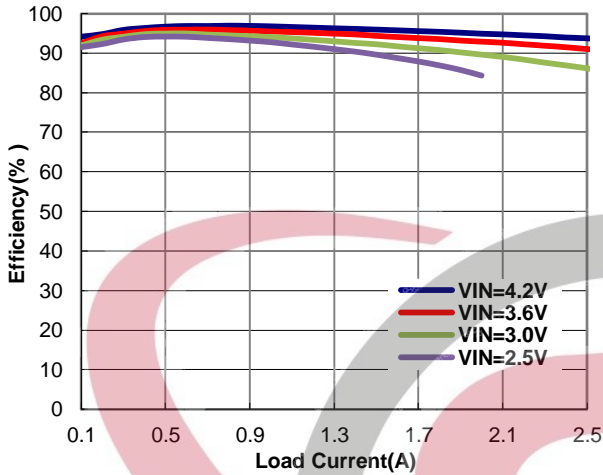

Figure 4. Efficiency vs. Output Current (VOUT=5V)

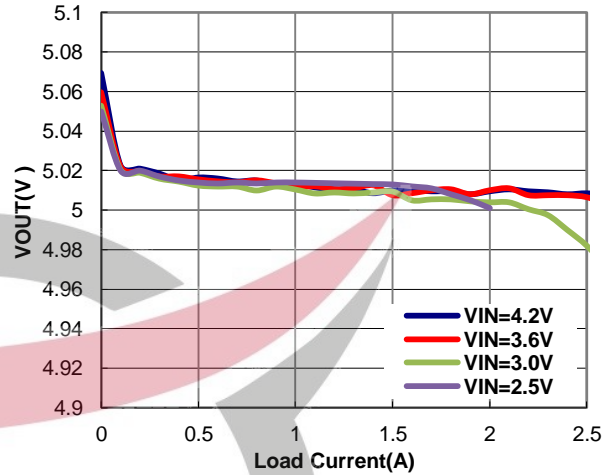

Figure 5. Output Voltage vs. Output Current

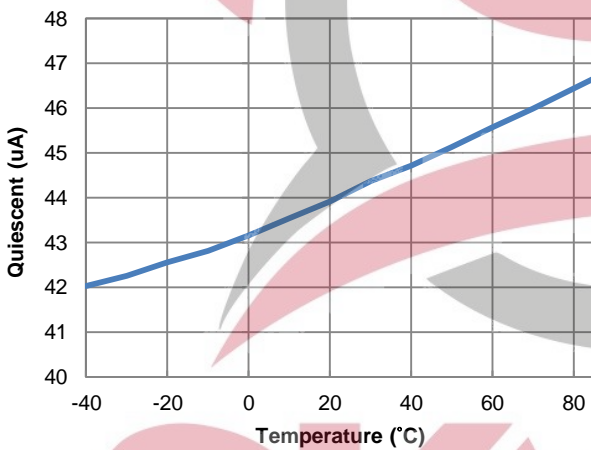

Figure 6. Quiescent Current vs. Temperature

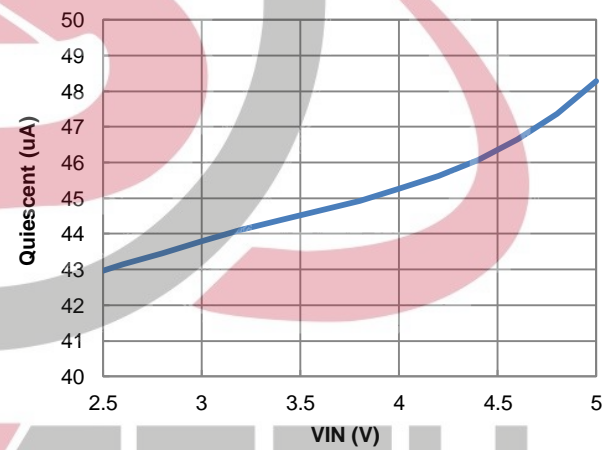

Figure 7. Quiescent Current vs. VIN

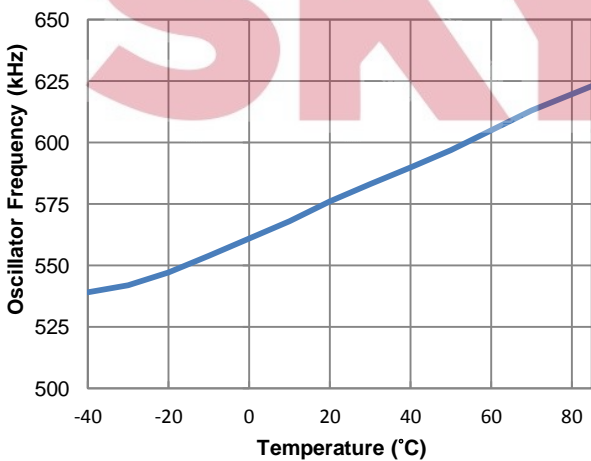

Figure 8. Oscillator Frequency vs. Temperature

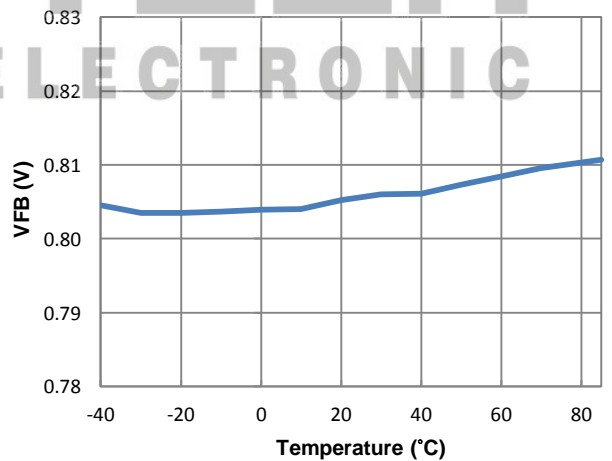

Figure 9. Feedback Voltage vs. Temperature

Typical Performance Curves (Continued)

$V_{IN}=3.6V, V_{OUT}=5V, I_{OUT}=500mA$

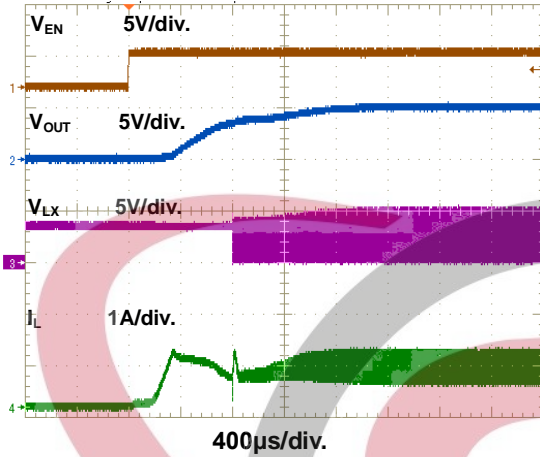

Figure 10. Power On through EN Waveform

$V_{IN}=3.6V, V_{OUT}=5V, I_{OUT}=500mA$

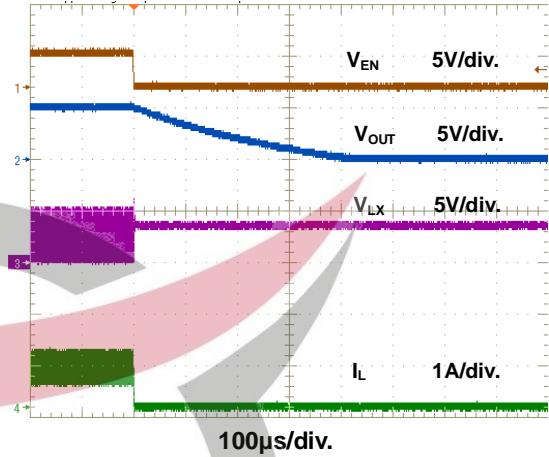

Figure 11. Power Off through EN Waveform

$V_{IN}=3.6V, V_{OUT}=5V, I_{OUT}=500mA$

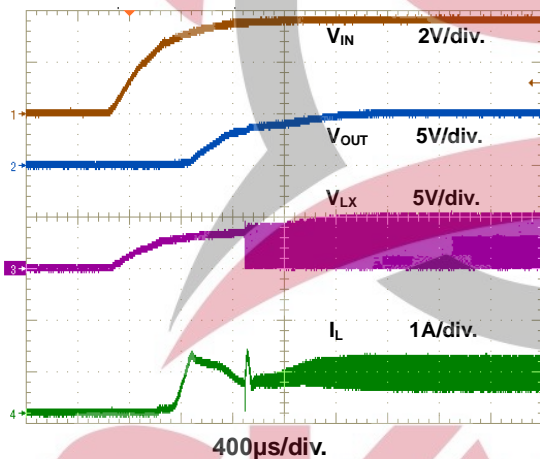

Figure 12. Power On through VIN Waveform

$V_{IN}=3.6V, V_{OUT}=5V, I_{OUT}=500mA$

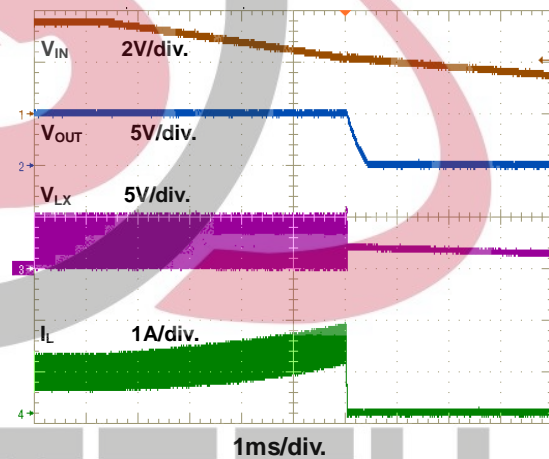

Figure 13. Power Off through VIN Waveform

$V_{IN}=3.6V, V_{OUT}=5V, I_{OUT}=20mA$

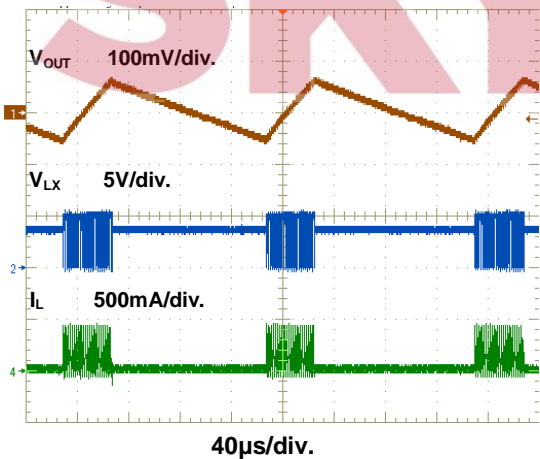

Figure 14. Switching Waveform

$V_{IN}=3.6V, V_{OUT}=5V, I_{OUT}=1A$

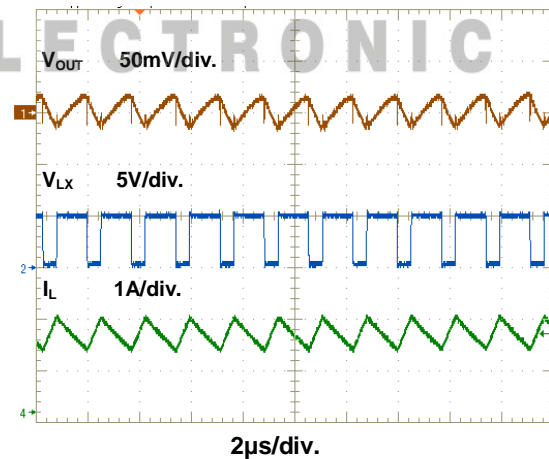

Figure 15. Switching Waveform

Typical Performance Curves (Continued)

$V_{IN}=3.6V$, $V_{OUT}=5V$, $I_{OUT}=50mA \rightarrow 500mA$, PSM \rightarrow PWM

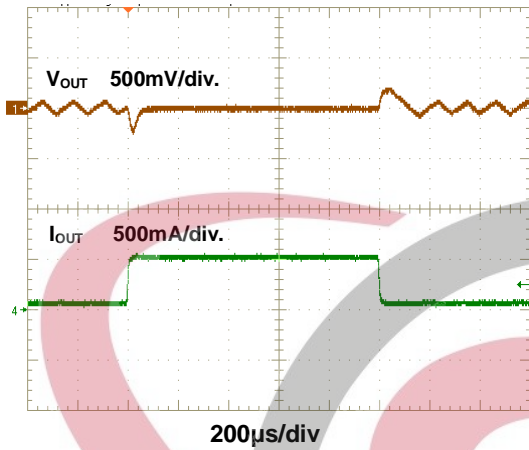

Figure 16. Load Transient Response

$V_{IN}=3.6V$, $V_{OUT}=5V$, $I_{OUT}=500mA \rightarrow 1500mA$

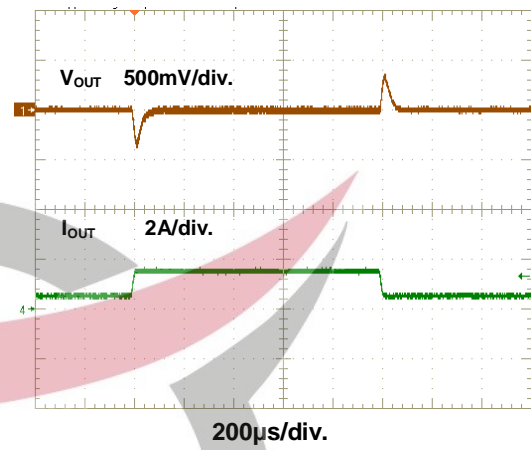

Figure 17. Load Transient Response



Application Information

Controller Circuit

The device is based on a current-mode control topology and uses a constant frequency pulse-width modulator to regulate the output voltage. The controller limits the current through the power switch on a pulse by pulse basis. The current sensing circuit is integrated in the device; therefore, no additional components are required. Due to the nature of the boost converter topology used here, the peak switch current is the same as the peak inductor current, which will be limited by the integrated current limiting circuits under normal operating conditions.

Synchronous Rectifier

The device integrates a N-channel and a P-channel MOSFET transistor to realize a synchronous rectifier. There is no additional Schottky diode required. Because the device uses an integrated low $R_{DS(ON)}$ PMOS switch for rectification, the power conversion efficiency reaches 90%.

A special circuit is applied to disconnect the load from the input during shutdown of the converter. In conventional synchronous rectifier circuits, the backgate diode of the high-side PMOS is forward biased in shutdown and allows current flowing from the battery to the output. This device, however, uses a special circuit to disconnect the backgate diode of the high-side PMOS and so, disconnects the output circuitry from the source when the regulator is not enabled (EN=low).

PSM Mode

The FP6716 is designed for high efficiency over wide output current range. Even at light load, the efficiency stays high because the switching losses of the converter are minimized by effectively reducing the switching frequency. The controller will enter a power saving mode if certain conditions are met. In this mode, the controller only switches on the transistor if the output voltage trips below a set threshold voltage. It ramps up the output voltage with one or several pulses, and goes again into PSM mode once the output voltage exceeds a set threshold voltage.

Device Enable

The device will be shut down when EN is set to GND. In this mode, the regulator stops switching, all internal control circuitry including the low-battery comparator will be switched off, and the load will be disconnected from the input (as described in above synchronous rectifier section). This also means that the output voltage may drop below the input voltage during shutdown.

The device is put into operation when EN is set high. During start-up of the converter, the duty cycle is limited in order to avoid high peak currents drawn from the battery. The limit is set internally by the current limit circuit.

Anti-Ringing Switch

The device integrates a circuit which removes the ringing that typically appears on the SW node when the converter enters the discontinuous current mode. In this case, the current through the inductor ramps to zero and the integrated PMOS switch turns off to prevent a reverse current from the output capacitors back to the battery. Due to remaining energy that is stored in parasitic components of the semiconductors and the inductor, a ringing on the SW pin is induced. The integrated anti-ringing switch clamps this voltage internally to V_{IN} ; therefore, dampens this ringing.

Adjustable Output Voltage

The accuracy of the output voltage is determined by the accuracy of the internal voltage reference, the controller topology, and the accuracy of the external resistor. The reference voltage has an accuracy of $\pm 2\%$. The controller switches between fixed frequency and PSM mode, depending on load current. The tolerance of the resistors in the feedback divider determines the total system accuracy.

Design Procedure

The FP6716 boost converter family is intended for systems that are powered by a single-cell Li-ion battery with a typical terminal voltage between 3V to 4.2V.

Application Information (Continued)

~~(1) Current Limit Resistor (R_{ILIM}) Selection~~

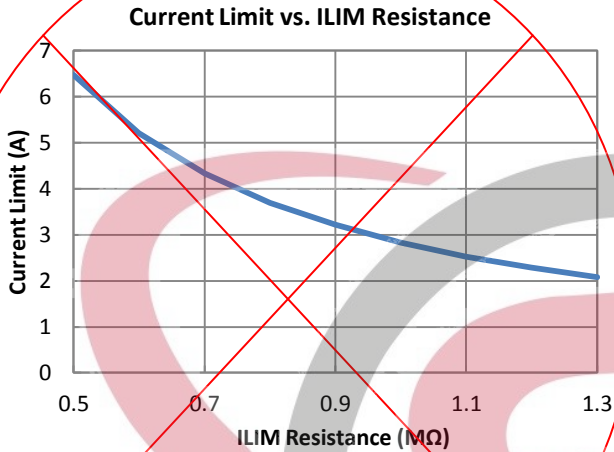

ILIM Resistance (MΩ)	Typical Current Limit (A)
0.5	6.4
1	3.6
1.3	2

(2) Programming the Output Voltage

The output voltage of the FP6716 can be adjusted with an external resistor divider. The typical value of the voltage on the FB pin is 800mV in fixed frequency operation. The maximum allowed value for the output voltage is 5.25V. The current through the resistive divider should be about 100 times greater than the current into the FB pin. The typical current into the FB pin is 0.01µA, and the voltage across R2 is typically 800mV. Based on those two values, the recommended value for R2 is in the range of 80kΩ in order to set the divider current at 10µA. From that, the value of resistor R1, depending on the needed output voltage (V_O), can be calculated using Equation 1.

$$R1=R2 \times \left(\frac{V_{OUT}}{V_{FB}} - 1 \right) = 80k\Omega \times \left(\frac{V_{OUT}}{800mV} - 1 \right) \dots\dots(1)$$

(3) Inductor Selection

A boost converter normally requires two main passive components for storing energy during the conversion. A boost inductor is required and a storage capacitor at the output. To select the boost inductor, it is recommended to keep the possible peak inductor current below the current limit threshold of the power switch in the chosen configuration.

The second parameter for choosing the inductor is the desired current ripple in the inductor. Normally, it is advisable to work with a ripple of less than 20% of the average inductor current. A smaller ripple reduces the magnetic hysteresis losses in the inductor, as well as output voltage ripple and EMI. But in the same way, regulation time at load changes rises. In addition, a larger inductor increases the total system cost. With those parameters, it is possible to calculate the value for the inductor by using Equation 2.

$$L = \frac{V_{IN} \times (V_{OUT} - V_{IN})}{\Delta I_L \times f \times V_{OUT}} \dots\dots(2)$$

Parameter f is the switching frequency and ΔI_L is the ripple current in the inductor, i.e, 20% x I_L. With this calculated value and currents, it is possible to choose a suitable inductor. Care must be taken that load transients and losses in the circuit can lead to higher currents. Also, the losses in the inductor caused by magnetic hysteresis losses and copper losses are a major parameter for total circuit efficiency.

(4) Capacitor Selection

The major parameter necessary to define the output capacitor is the maximum allowed output voltage ripple of the converter. This ripple is determined by two parameters of the capacitor, the capacitance and the ESR. It is possible to calculate the minimum capacitance needed for the defined ripple, supposing that the ESR is zero, by using Equation 3.

$$C_{MIN} = \frac{I_{OUT} \times (V_{OUT} - V_{IN})}{f \times \Delta V \times V_{OUT}} \dots\dots(3)$$

Parameter f is the switching frequency and ΔV is the maximum allowed ripple.

The total ripple is larger due to the ESR of the output capacitor. This additional component of the ripple can be calculated using Equation 4.

$$\Delta V_{ESR} = I_{OUT} \times R_{ESR} \dots\dots(4)$$

Application Information (Continued)

The total ripple is the sum of the ripple caused by the capacitance and the ripple caused by the ESR of the capacitor. It is possible to improve the design by enlarging the capacitor or using smaller capacitors in parallel to reduce the ESR or by using better capacitors with lower ESR, like ceramics. Tradeoffs must be made between performance and costs of the converter circuit.

A 10 μ F input capacitor is recommended to improve transient behavior of the regulator. A ceramic or tantalum capacitor with a 100nF in parallel placed close to the IC is recommended.

A 22 μ F output capacitor is recommended to improve transient behavior of the regulator. A ceramic or tantalum capacitor with a 100nF in parallel placed close to the IC is recommended.

Layout Considerations

As for all switching power supplies, the layout is an important step in the design, especially at high peak currents and high switching frequencies. If the layout is not carefully done, the regulator could show stability problems as well as EMI problems. Therefore, use wide and short traces for the main current path as indicated in bold in Figure 18. The input capacitor, output capacitor should be placed as close to the IC as possible. Use a common ground node as shown in Figure 18 to minimize the effects of ground noise. The feedback divider should be placed as close to the IC as possible.

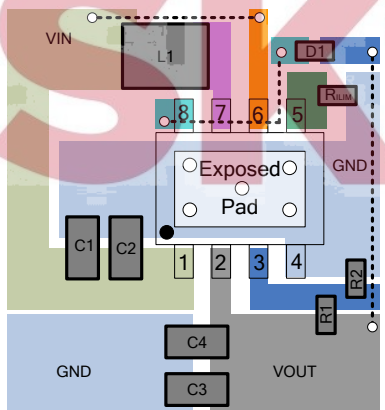
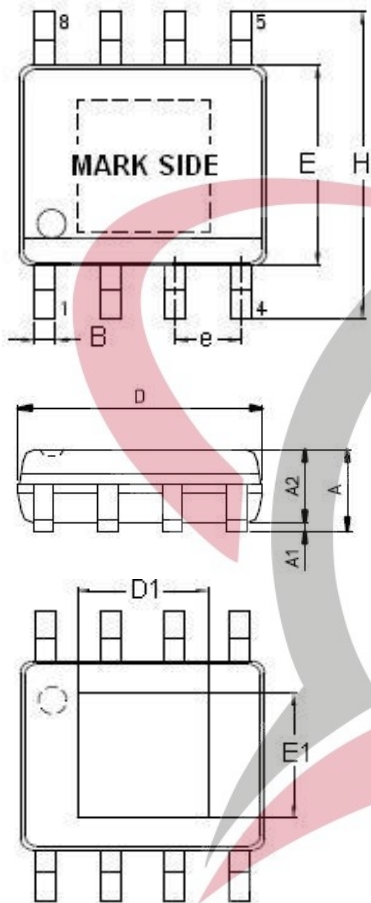

Figure 18. Layout Diagram

Outline Information

SOP-8 (Exposed Pad) Package (Unit: mm)



SYMBOLS UNIT	DIMENSION IN MILLIMETER	
	MIN	MAX
A	1.25	1.70
A1	0.00	0.15
A2	1.25	1.55
B	0.31	0.51
D	4.80	5.00
D1	3.04	3.50
E	3.80	4.00
E1	2.15	2.41
e	1.20	1.34
H	5.80	6.20
L	0.40	1.27

Note : Followed From JEDEC MO-012-E.

Carrier Dimensions

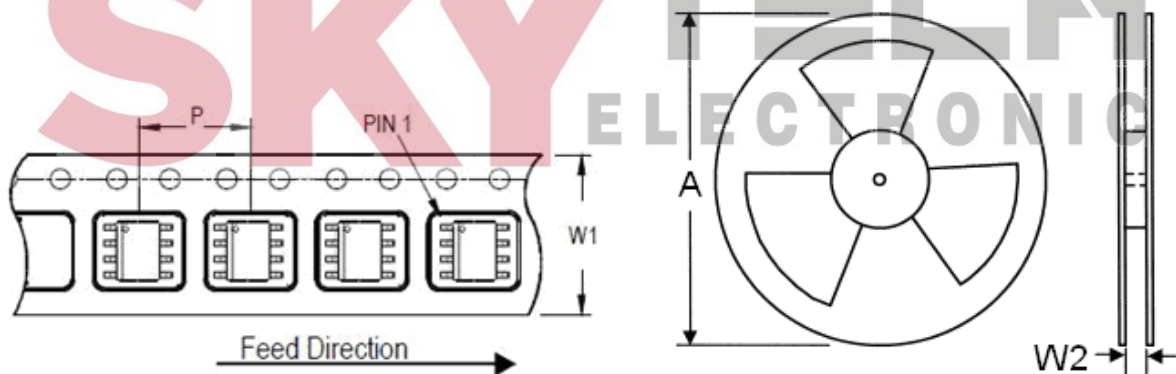

Tape Size (W1) mm	Pocket Pitch (P) mm	Reel Size (A)		Reel Width (W2) mm	Empty Cavity Length mm	Units per Reel
		in	mm			
12	8	13	330	12.4	400~1000	2,500

Life Support Policy

Fitipower's products are not authorized for use as critical components in life support devices or other medical systems.